

# anglianplant

Plant & Tool | Hire & Sales



Follow us on...



@anglianplant



Anglian Plant Limited



@anglianplant



@anglianplant



Anglian Plant Limited

**Anglian Plant Limited is an ISO Accredited Company**

- Environmental Management System
- Occupational Health & Safety Management System
- Quality Management System



# All the plant for all the people made easy

Incorporated in 2009, based in Norwich, Norfolk, Anglian Plant supply all manor of plant and tools throughout East Anglia. We stock a vast range of equipment from leading brands ranging from wacker plates to 40 tonne excavators. Our aim is to be a one stop shop for anything plant, meaning you don't have to go anywhere else!

We have a friendly, knowledgeable team on hand to help with any enquiries and to support you throughout the hire process. From the top to the bottom we believe in keeping things simple and offering a customer service experience which is transparent, reliable and adds value.

Whether it's a dozer an ADT or a stihl saw, we'd be happy to assist with your requirements!





# Index

Excavators	5-11
Excavator Attachments	12-13
Grab Lorry Hire	14
GPS Machine Control	16
Wheel Diggers/Backhoes & Chipper	17
Site Dumpers & Dumper Cabins	18-26
Dozer	28
Telescopic Handlers	29-33
Telehandler Attachments	34
Counter Balance Fork Trucks	35-36
Rollers	37-41
Screener	42
Concrete Crusher	43
Access Platforms & Scissor Lifts	45-50
Bowers	51
Compressors	52
Safety	53
Lighting Tower	54
Operated Plant Hire	55
Tool Hire Trade Counter	56
Mobile Welfare	57-58
Tractors	59
Tractor Attachments	60
ATVs	61
NEW Small Tools	62-77
Blade Sales	78
Plant Sales	79
Haulage	80
Calendar	81
How To Hire / Contact Details	82

## 1 Tonne Micro Excavator

- Weight 1176 kg
- Length 2793 mm
- Width 710 / 1100mm
- Height 2209mm
- Digging Depth 1820mm



## 1.7 Tonne Mini Excavator

- Width 990 / 1240mm
- Height 2340mm
- Weight 1650kg
- Length 3545mm
- Dig Depth 2460mm



## 1.6 Tonne Mini Excavator

- Width 990 / 1240mm
- Height 2350mm
- Weight 1540kg
- Length 3710mm
- Dig Depth 2250mm



## 2.7 Tonne Mini Digger

- Width 1690mm
- Height 2550mm
- Weight: 4775kg
- Length: 5330mm
- Dig Depth: 3380mm
- Arm Length: 1450mm

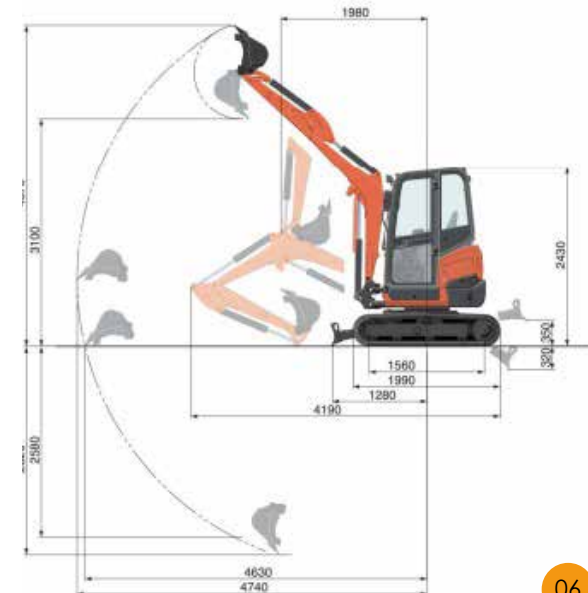

## 5 Tonne Midi Excavator

- Make Kubota
- Model U50-5
- Weight 4965kg
- Dump Height 4000mm
- Dig Depth 3560mm
- Max Digging Reach 5330mm
- Machine Width 1960mm
- Machine Height 2550mm
- Ground Clearance 320mm

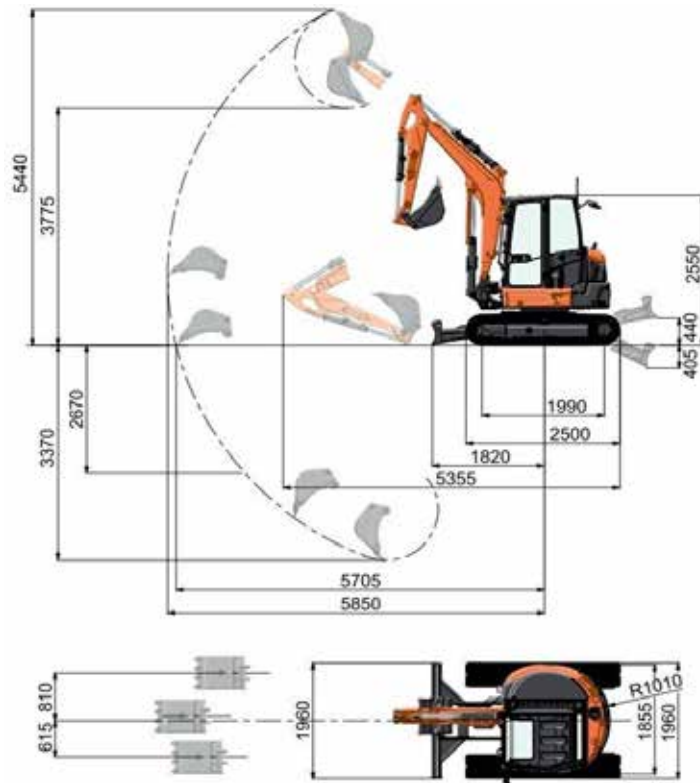

## 8 Tonne Midi Excavator

- Width 2200mm
- Height 2540mm
- Weight 8425kg
- Length 6450mm
- Dig Depth 4600mm



## 14 Tonne Excavator

- Width 2690mm
- Height 2920mm
- Weight 14200kg
- Length 7810mm
- Dig Depth 5980mm



## 14 Tonne Zero Tail Swing Excavator



- Machine Weight 14,300kg
- Machine Width 2690mm
- Machine Height 2780mm
- Digging Height 9690mm
- Digging Depth 5790mm
- Digging Reach 9690mm

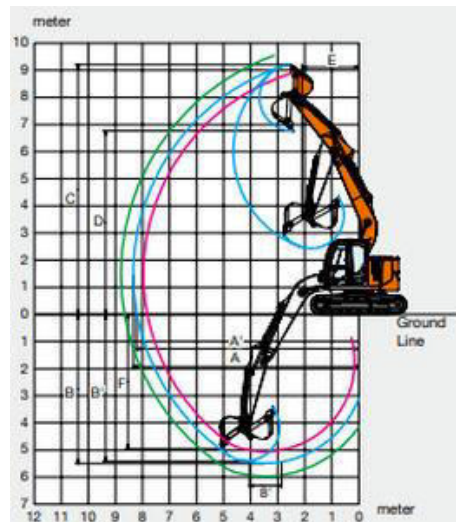

## 24 Tonne Zero Tail Swing Excavator



- Weight 25200kg
- Length 9110mm
- Width 3090mm
- Height 3030mm
- Dig Depth 6620mm
- Dig Reach 10110mm

## 30 Tonne Excavator



- Weight 29900kg
- Length 10710mm
- Width 3190mm
- Height 3120mm
- Dig Depth 7200mm
- Dig Reach 10710mm

## 35 Tonne Excavator

- Width 3400mm
- Height 3470mm
- Weight 37414kg
- Length 11170mm
- Dig Depth 6720mm



## Excavator Attachments

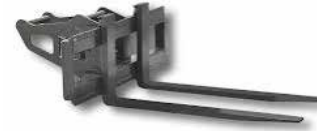

Pallet forks to suit 5 -22 tonne excavators



Selector Grabs to suit 5 - 22 tonne excavators



Tree Shear to suit 8 & 14 Tonne Excavators

## 10 Tonne Long Reach Excavator

- Width 2300mm
- Height 2550mm
- Tip Height 7000mm
- Reach 10100mm
- Depth 7200mm
- Tail swing Radius 1835mm
- Ground Clearance 370mm
- Track Length 2855mm
- Track pad width 450mm



Rubber Street Pads/ Road Liners



Grading Beam



Flail Mower to suit 6 & 8 tonne excavators

## 15 Tonne Long Reach Excavator

- Width 2790mm
- Height 2920mm
- Track pad width 800mm
- Max Reach 12000mm



Earth Rake



Riddle Rake



V Bucket



Riddle/shaker Buckets to suit  
3 - 22 tonne excavators



Hydraulic Breakers to suit  
1 – 35 tonne excavators



Vibrating Plates to suit 14 - 22  
tonne excavators



Earth Drills / Augers to suit  
1.5 -14 tonne excavators



Reed cutting Bucket



Digging Clam Shell



**Skip Free  
Muck Away**

## Grab Lorry Hire

Anglian Plant Hire operate a fleet of 6 and 8 wheel tipper grab lorries. We undertake spot hires, contract hires and day rate hires for muck away and aggregate deliveries.

**01603 975000 • [hire@anglianplant.com](mailto:hire@anglianplant.com)**

Anglian Plant Ltd. The Old Coal Yard,  
Muck Lane, Rackheath, Norfolk, NR13 6S





SCAN ME



REVIEW US

SCAN ME



VISIT OUR WEBSITE



## GPS Machine Control

Available throughout  
our product range

- Improved Data Handling
- Reduce Costs, increase productivity
  - Simplified Work Progress
- Increase Safety Awareness



## Wheel Digger / Backhoe Loader

- Weight 8070kg
- Width 2350mm
- Height 2910mm
- Dig depth 5970mm



## 1 Tonne High Tip Dumper

- Unladen weight 1295kg
- Width: Normal Wheels 1115mm
- Height (Rops Up) 2860mm
- Height (Rops Down) 1773mm
- Maximum tipping height 1573mm
- Skip capacity 500Ltr
- Length 3032mm
- Maximum safe load 1000kg



## 6" Tracked Chipper

- Stage V Compliant Diesel Engine
  - WolfTrack
  - Variable Width
  - Dual Speed Tracking System.
- The go-to Tracked Machine for the Professional Arborist.*
- Class Leading 230mm x 160mm (6 inch) Feed Opening
  - Minimum Width 810mm.
  - Kubota V1505 Diesel Engine



Available to hire with or without a trailer by the week day or longer!

## 2 Tonne High Tip Swivel Dumper

- Unladen weight 2360mm
- Width 1488mm
- Height (Rops up) 3053mm
- Height (Rops down) 2028mm
- Maximum tipping height 3642mm
- Skip capacity 1205Ltr
- Length 3891mm
- Maximum safe load 2000kg



## 3 Tonne Straight Tip Dumper

- Carrying capacity 3000kg
- Machine length 165mm
- Machine width 3.774m



## 6 Tonne Straight Tip Dumper

- Carrying capacity 6000kg
- Machine length 4475mm
- Machine width 2240mm



## 3 Tonne Swivel Tip Dumper

- Unladen weight 2160kg
- Width 1650mm
- Height (Rops Up) 3092mm
- Height (Rops Down) 1965mm
- Maximum tipping height 735mm
- Skip capacity 1640Ltr
- Length 3935mm
- Maximum safe load 3000kg



## 6 Tonne Swivel Tip Dumper

- Unladen weight 4340kg
- Width 2280mm
- Height (Rops Up) 3300mm
- Height (Rops Down) 2230mm
- Maximum tipping height 1100mm
- Skip capacity 3150Ltr
- Length 4750mm
- Maximum safe load 6000kg



## 6 Tonne Dumper Cabin

- Weight 4340kg
- Width 2280mm
- Cab height 3300mm
- Tipping height 1100mm
- Skip Capacity 3150Ltr
- Length 4750mm
- Max safe load 6000kg



## 9 Tonne Dumper Cabin

- Unladen weight 5290 kg
- Width 2444 mm
- Height 3588 mm
- Maximum tipping height 436mm
- Skip capacity 4600 lts
- Length 4670mm
- Maximum safe load 9000 kg



## 9 Tonne Dumper

- Unladen weight 4870 kg
- Width 2444 mm
- Height (Rops up) 3530 mm
- Height (Rops down) 2555 mm
- Maximum tipping height 436mm
- Skip capacity 4600Ltr
- Length 4670mm
- Maximum safe load 9000 kg



## 6 Tonne Duel View

- Length 4450mm
- Weight 4252kg
- Width 2230mm
- Payload 6000kg
- Height 2,940mm



## 9 Tonne Duel View

- Weight 5250kg
- Width 2.42m
- Length 4.89m
- Height 2.94m
- Max Safe Capacity 9000kg



## 20 Tonne LGP Articulated Dump Truck

- Unladen weight 15900 kg
- Width 2930 mm
- Height 3440 mm
- Length 9140 mm
- Maximum safe load 20000 kg



## 12 Tonne Rear tip LGP Dumper

- Unladen weight 12000kg
- Width 2490 mm
- Height 2750 mm
- Length 5940mm
- Maximum safe load 10000 kg



## 0.5 Tonne Tracked Dumper

- Machine weight 475kg
- Carrying capacity 500kg
- Clearance tipping 1450mm
- Machine length 170mm
- Machine width 690mm



## 1 Tonne Tracked High Tip Dumper

- Payload 1000kg
- Weight 770kg
- Tipping Height 1340mm
- Width 750mm
- Length 1950mm
- Height 1325mm



## 5 Tonne Tracked Dumper

- Carrying capacity 5000kg
- Machine length 5950mm
- Machine width 2490mm



## 2.5 Tonne Tracked Dumper

- Weight 2430kg
- Height 2370mm
- Width 1550mm
- Loading capacity 2500kg
- 2 speed tracking
- 84 deg tip angle
- 180 deg swivel tip
- Reversible Seat Position
- Rops Canopy
- Bumper and Lights

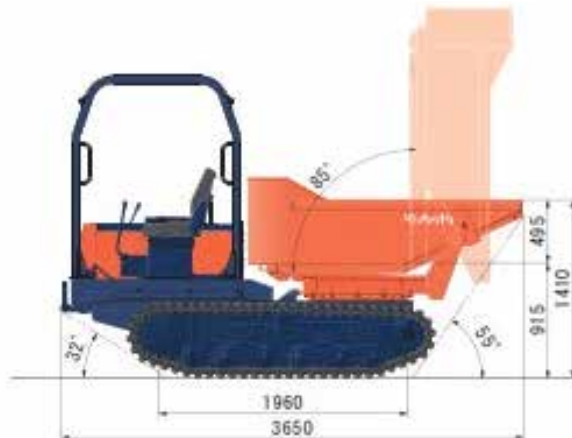

## Dozer D6K

- Weight 13.5t
- Length 3.8m
- Width 2.8m
- Height 3m
- Track Width 760mm
- Front Blade Width 3.7m



## 4m Trailer Telehandler

- Width 1564mm
- Length 3944mm
- Height 1995mm
- Lift Height 4301mm
- Boom In 1250kg
- Boom Out 440kg



## Dozer D6N

- Weight 17.3t
- Length 4.149m
- Width 3.02m
- Height 3.19m
- Track Width 860mm
- Front Blade Width 4.08m



## 4m Telescopic Telehandler

- Lifting height 4.3 metres
- Lifting capacity 2000kg
- Turning Radius 2.98
- W x L x H 1.49 x 3.6 x 1.9m
- Weight 4260kg



## 6m Lift Telescopic Telehandler

- Lifting Height 5.85m
- Lifting Capacity 2500kg
- Turning Radius 3.31m
- WxLxH 1.81 x 3.9 x 1.92m
- Weight 4800kg



## 9.5m Lift Telescopic Telehandler



## 7m Lift Telescopic Telehandler

- Lift Capacity 3.1 Tonnes
- Max Lift Height 7 Metres
- Width 2230mm
- Length 4990mm
- Height 2490mm



- Lift Capacity 3.5 Tonnes
- Max Lift Height 9.5 Metres
- Width 2290mm
- Length 4990mm
- Height 2490mm



## 10.5m Lift Telescopic Telehandler

- Lift Capacity 3.3 Tonnes
- Max Lift Height 10.2 Metres
- Width 2290mm
- Length 5380mm
- Height 2490mm



## 17m Lift Telescopic Telehandler

- Lift Capacity 4 Tonnes
- Max Lift Height 16.7m
- Width 2440mm
- Length 6360mm
- Height 2690mm



## 14m Lift Telescopic Telehandler

- Lift Capacity 4 Tonnes
- Max Lift Height 13.8m
- Width 2350mm
- Length 6250mm
- Height 2590mm



## 20m Lift Telescopic Telehandler

- Lift Capacity 4 Tonnes
- Max Lift Height 16.7m
- Width 2440mm
- Length 6360mm
- Height 2690mm

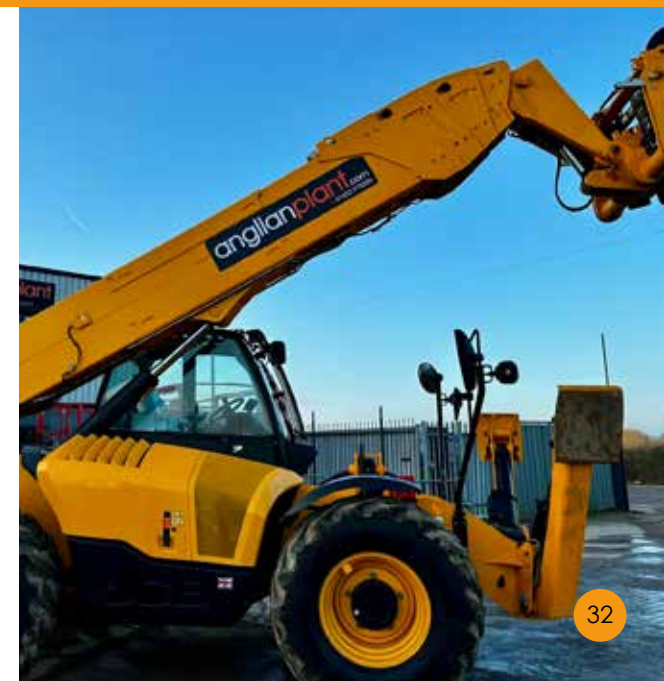



- Manitou MLT737-130PS+ 40kph
- Max Capacity 3700kg
- Max Lift 6900mm
- Max outreach 3900mm
- Unladen weight 7650kg
- Width 2390mm
- Length 4970mm
- Height 2380mm



Telehandler Sweeper Attachment



General purpose bucket to suit 4m to 17m Telehandlers



Man Cage/Basket to suit 4m to 17m Telehandlers



Telehandler Tipping Skip



Pallet Fork Extensions



Telehandler Jib Attachment 1.5 tonne



Telehandler hook attachment



Hydraulic Truss Master



## Counter Balance Fork Trucks

Diesel & Electric  
Various Lift & Height Capabilities Available

## Single Drum 55cm Vibrating Roller

- Drum Width 560mm
- Operating Weight 161kg
- Fuel Petrol



## Twin Drum Trench Roller

- Twin Drum Trench Roller
- Radio Control
- Drum Width 610 – 850mm
- Operating Weight 1595kg



## Single Drum 71cm Vibrating Roller

- Drum Width 710mm
- Operating Weight 512kg
- Fuel Diesel
- C/W Trailer & optional Breaker



## 80cm Twin Drum Vibrating Roller

- Drum Width 800mm
- Operating Weight 1620kg



## 100cm Twin Drum Vibrating Roller

- Total Length 2260mm
- Width 1056mm
- Height Loading min 1580mm
- Total Height 2210mm
- Drum Width 1000mm
- Operating Weight 1670kg



## 135 Roller



## 120cm Twin Drum Vibrating Roller

- Drum Width 1200mm
- Operating Weight 2700kg



- Weight 3.96 Tonnes
- Transport Length 2.9 Metres
- Transport Width 1.43 Metres
- Transport Height 2.59 Metres
- Drum Width 1300mm

## 10 Tonne Roller

### Smooth or Pad Foot Options

- Weight 10.55t
- Transport Length 5.85m
- Transport Width 2.3m
- Transport Height 3.11m
- Drum Width 2113mm



## 15 Tonne 3 Way Screener



## 13 Tonne Roller

### Smooth or Pad Foot Options

- Weight 15.35t
- Transport Length 5.9m
- Transport Width 2.26m
- Transport Height 2.97m
- Drum Width 2113mm



- Weight 16.5t
- Transport length 9.88m
- Transport width 2.55m
- Transport height 3.19m
- Screen width 1.22m
- Screen length 2.743m
- Hopper capacity 5 m<sup>3</sup>
- Main conveyor width 1050mm
- Side conveyor width 650mm



RM90GO! The Flexible High Performance Crusher is big brother to our RM70GO! It still is transported on a standard 44 tonne truck so cost effective to move from site to site but has an improved throughput of up to 200 tonnes per hour.

- Operating Weight 23600kg
- Jaw Width 860 x 650mm
- Loading Height 2880mm
- Discharge Height 2950mm
- Over Conveyor Magnetic Separator
- Dust suppression



# weekend warriors MEGA HIRE DEAL

**1t Digger**  
Weekend Hire  
£225!

**1.5t Digger**  
Weekend Hire  
£225!

**3t Digger**  
Weekend Hire  
£275!!

Fixed Price Inclusive of Transport, Fuel & VAT Terms: payment and damage deposit payable up front, Identification required, within 25 miles NR13 only, fuel included one tank only. Anglian Plant Ltd. The Old Coal Yard, Muck Lane, Rackheath, Norfolk, NR13 6ST

## 8 metre Electric Scissor Lift

- Working Height 8.2m
- Lifting Capacity 350kg
- Platform Size 3.22 x 0.8m



## 12 Metre Reach Towable Access Platform

- Working Height 12.33m
- Working Outreach 5m
- Safe Working Load 200kg
- Operating Weight 1195kg

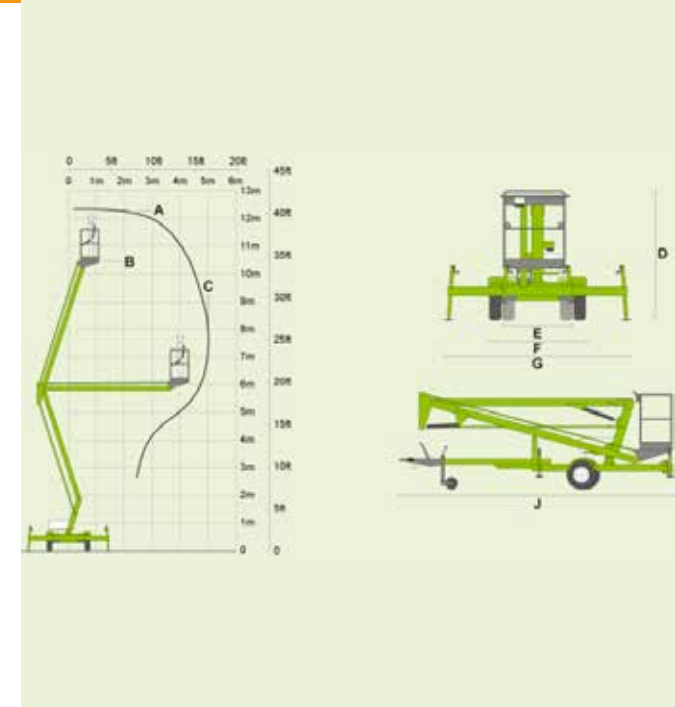

## 12 metre Electric Scissor Lift

- Working Height 11.75m
- Lifting Capacity 320kg
- Platform Size 1.22 x 3.02



## 17 Metre Reach Towable Access Platform

- Working Height 17.1m
- Working Outreach 8.7m
- Safe Working Load 200kg
- Operating Weight 1900kg

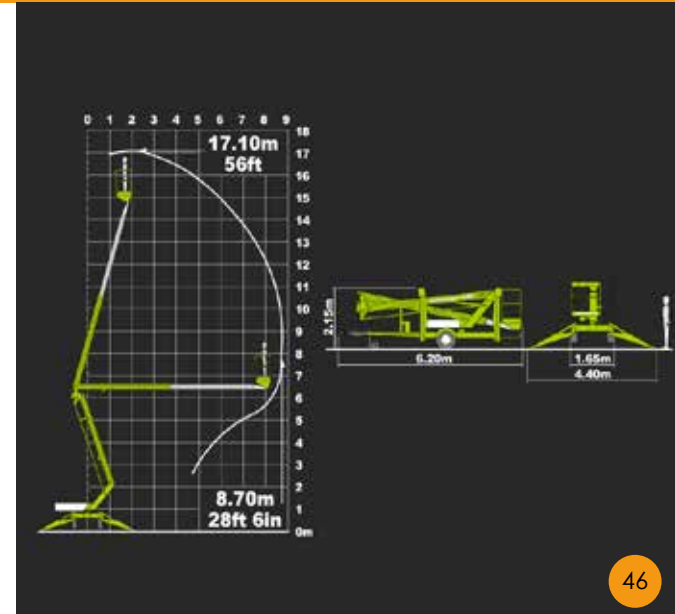



## 10 metre Rough Terrain Diesel Scissor Lift

- Working Height 10.15m
- Lifting Capacity 565kg
- Platform Size 3.7 x 1.54m



## 14m Tracked Access Platform

- Working Height 14m
- Working Outreach 7m
- Safe Working Load 200kg
- Operating Weight 1700kg
- Travel Width 0.78m



## 12 metre Rough Terrain Diesel Scissor Lift

- Working Height 12m
- Lifting Capacity 300kg
- Platform Size 3.22 x 1.2m



## 20m Tracked Access Platform

- Working Height 20.1m
- Working Outreach 9.7m
- Safe Working Load 230kg
- Operating Weight 2840kg
- Travel Width 0.79m



## 16 Metre Self Propelled Access Platform



- Working Height 15.72m
- Working Outreach 8.12m
- Safe Working Load 227kg

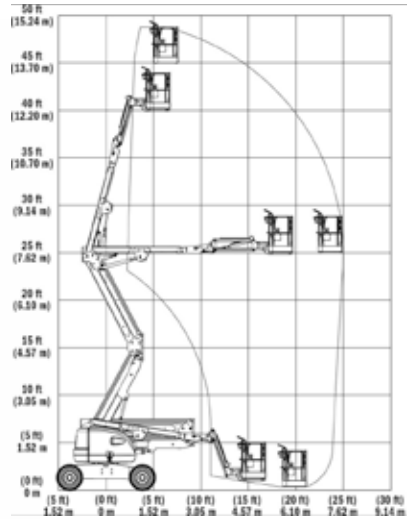

## 26 Metre Self Propelled Access Platform

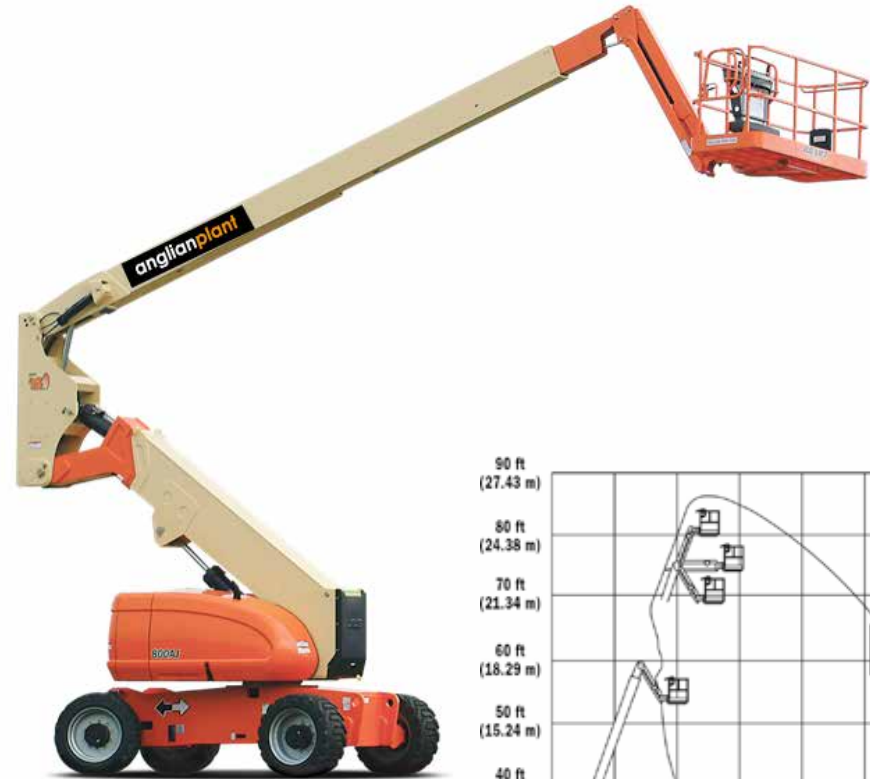

- Working Height 26.38m
- Working Outreach 16.45m
- Safe Working Load 230kg

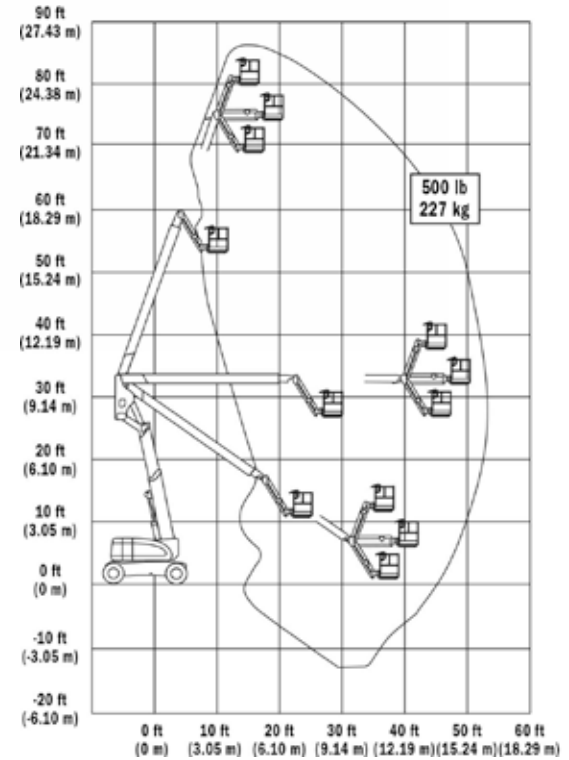

## 20 Metre Self Propelled Access Platform



- Working Height 20.46m
- Working Outreach 12.75m
- Safe Working Load 230kg

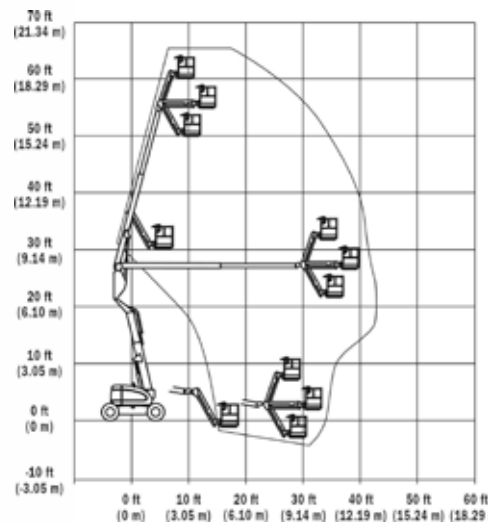



## Bowers

- Diesel Pressure Washer Bowers
- Road Tow, Site Tow and Static Fuel Bowers in various sizes
- Towable Water Bowers
- Dust suppression

## Compressors

- Road Tow Compressors
- 2 tool 140 & 190 com
- Choice of picks, breakers & lances

# SAFETY



All equipment is monitored and inspected in conjunction with LOLER, PUWER & THOROUGH EXAMINATION regulations.

In addition we can offer additional safety items such as:

Green Seat Belt warning Beacons

Vehicle Collision Avoidance Systems

Excavator Hand/Guard Rails

180/360 Vision Cameras

Audible Reversing Alarm

Height Restrictors

Speed/gear restriction/reduction



- Maximum Height 9m
- Run Time 60 Hours
- Flood Lights 4 x 1000w
- Weight 1115kg



## Operated Plant Hire

All plant listed in this catalogue can be supplied not only on a self drive basis but also complete with a CPCS card holding operator.

01603 975000 • [hire@anglianplant.com](mailto:hire@anglianplant.com)

[www.anglianplant.com](http://www.anglianplant.com)

Anglian Plant Ltd, The Old Coal Yard, Muck Lane, Rackheath, Norfolk, NR13 6ST



## Tool Hire

As well as our range of plant we offer a comprehensive selection of tools such as:

Compaction Plates • Trench Rammers • Water Pumps  
Disc Cutters • Alloy Scaffold Tower • Site Mixers • Pokers  
Laser Levels • Cat Scanners • Floor Saws • Hydraulic breaker packs

More tools on pages 58-73

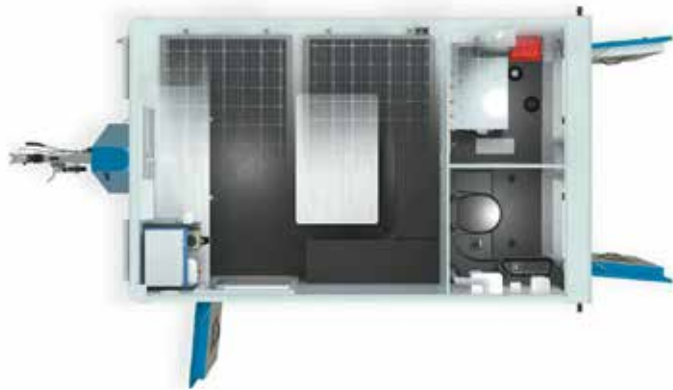

Ground lowering, anti-vandal, mobile, site accommodation unit

The GP360 Fusion Mobile Welfare Unit provides all the benefits of the standard unit plus many Eco features to reduce running costs and carbon footprint. It is a lightweight and compact towable unit that meets HSE requirements and provides all your on-site needs in one small package. The unit can be run for 2 hours to gain 8 hours worth of heating and lighting. After 2 hours the unit will stop but heating and lighting continues to run saving money on fuel usage and reducing noise pollution.



Spacious, comfortable, well equipped, easily towed & secured

The double axle Groundhog Mobile Welfare Unit GP500D is a lightweight and compact towable unit that meets HSE requirements and provides all your on-site needs in one small package.

The units are suitable for accommodating ten persons, which provides pleasant and safe working environments, ideal for rental companies and contractors. Easily towed, one man operation secured and manoeuvred on site, in less than 3 minutes. Its' many safety features make it a high secure and money saving choice of welfare unit for rental companies and contractors.

## 40 HP Tractor

- Weight without attachment 1.27t
- Transport Length 2.94m
- Transport width 1.25m
- Transport height 2.16m



## Tractor Attachments



## 100 HP Tractor

- Transport Length 4.045m
- Transport Width 2.068m
- Transport Height 2.65m
- Weight 3.055t





- Charging System 140 Amps
- Top Speed 65 kmph
- Towing Capacity 1134 kg
- Payload Capacity 720 kg
- Deeper Box 2.5 cm
- Length 43.5
- AWD True On-Demand
- EPS, EBS, ADC



2 Stroke Breakers



Hydraulic Pack and Gun



110v Hilti TE1000



110v Hilti TE3000





110v high Frequency poker 1''-3'' Fle



Petrol poker and 1''-3'' Flex



4/3 110v / 240v Mixer



5/3.5 Diesel Mixer



Paddle mixer



4/3 Petrol Mixer



Magi Screed  
2.44/3.05/3.66/4.27/4.88m  
beams and petrol unit



Double  
3.6/5.2/6.2/7.2m  
Beams & Drive unit



Petrol Compaction Plate 12"



Petrol Compaction Plate 16"



2.7kva Petrol Generator  
1 x 110v 16amp &  
1 x 240v 16amp plugs



5kva Petrol Generator  
1 x 16amp 110v / 1 x 32amp  
110v / 2 x 16amp 240v Plugs



Diesel Forward  
& Reverse Plate



Upright Rammer  
8" or 11"



55 Single Drum  
Petrol Rollers



6kva Diesel Generator  
2 x 16amp 110v /  
1 x 32amp 110v / 1 x 16amp  
240v / 1 x 32amp 240v plugs



10kva Diesel Generator  
1 x 16amp 110v / 2 x 32amp  
110v / 1 x 16amp 240v /  
1 x 32amp 240v plugs



Petrol 200amp Welder / Generator



Transformer 3kva / 5kva



9" Circular Saw  
Cutting depth 85mm



Jigsaw - 110v



14m Extension leads - 16amp 110v - 32amp 110v - 16amp 240v  
32amp 240v - 13amp 240v



Reciprocating saw 110v



Wall Chaser



4 Way Splitter box



12" Cut off Saw 4" cut depth



14" Floor Saw - 5" cut depth



18" Floor Saw - 6.5" Cut depth



2000psi Petrol Pressure Washer



3000psi Diesel Pressure Washer



Manual Tile Saw



110v Tile cutter



DC250 110V 16amp 55943 Rubi Bridge Saw



Wet & Dry Vacuum



Rug Doctor



STR701 c/w Drive Board



Floor Scabber FR200



Floor Tile Lifter



2" sub pump 110v



2" Puddle pump 110v



1" Petrol pump



2" Centrifugal pump



2" diaphragm pump



3" Diesel Diaphragm Pump



Strimmer -Line or Metal Head



Hedge Trimmer



Floor and Edge Sanders



Edge Sanders



Turf Cutter



Tilla



4" Belt Sander



12" Fume c/w ducting



1 Man Post hole Borer



Hydraulic Petrol Post Hole Borer



12" Fume c/w ducting



SDS plus Drill



SDS Max Drill



Signal Gen



Cable avoidance Tool



Laser Level



IM350 Nail gun



Cobra Reel



Pipe laser Level



SLA Genie Lifts 10/15/20



150kg slab Lifter



150kg slab Lifter



Duro Products Available To Purchase





## Plant Sales

We have a constantly changing selection of plant available to purchase.

**Finance available**

Call us with your requirements.  
01603 975000 or email [joe@anglianplant.com](mailto:joe@anglianplant.com)

## Haulage

We offer haulage for third party machinery using our fleet of low loaders and rigid beavertail lorries comprising of 7.5, 26, 32 and 44 tonne units.

Contact us today for a quote  
01603 975000 or email [hire@anglianplant.com](mailto:hire@anglianplant.com)

# Calendar 2024

## JAN 2024

M	T	W	T	F	S	S
1	2	3	4	5	6	7
8	9	10	11	12	13	14
15	16	17	18	19	20	21
22	23	24	25	26	27	28
29	30	31				

## FEB 2024

M	T	W	T	F	S	S
			1	2	3	4
5	6	7	8	9	10	11
12	13	14	15	16	17	18
19	20	21	22	23	24	25
26	27	28	29			

## MAR 2024

M	T	W	T	F	S	S
				1	2	3
4	5	6	7	8	9	10
11	12	13	14	15	16	17
18	19	20	21	22	23	24
25	26	27	28	29	30	31

## APR 2024

M	T	W	T	F	S	S
1	2	3	4	5	6	7
8	9	10	11	12	13	14
15	16	17	18	19	20	21
22	23	24	25	26	27	28
29	30					

## MAY 2024

M	T	W	T	F	S	S
	1	2	3	4	5	
6	7	8	9	10	11	12
13	14	15	16	17	18	19
20	21	22	23	24	25	26
27	28	29	30	31		

## JUN 2024

M	T	W	T	F	S	S
	1	2	3	4	5	
6	7	8	9	10	11	12
13	14	15	16	17	18	19
20	21	22	23	24	25	26
27	28	29	30			

## JUL 2024

M	T	W	T	F	S	S
1	2	3	4	5	6	7
8	9	10	11	12	13	14
15	16	17	18	19	20	21
22	23	24	25	26	27	28
29	30	31				

## AUG 2024

M	T	W	T	F	S	S
			1	2	3	4
5	6	7	8	9	10	11
12	13	14	15	16	17	18
19	20	21	22	23	24	25
26	27	28	29	30	31	

## SEPT 2024

M	T	W	T	F	S	S
					1	
2	3	4	5	6	7	8
9	10	11	12	13	14	15
16	17	18	19	20	21	22
23	24	25	26	27	28	29
30						

## OCT 2024

M	T	W	T	F	S	S
	1	2	3	4	5	6
7	8	9	10	11	12	13
14	15	16	17	18	19	20
21	22	23	24	25	26	27
28	29	30				

## NOV 2024

M	T	W	T	F	S	S
				1	2	3
4	5	6	7	8	9	10
11	12	13	14	15	16	17
18	19	20	21	22	23	24
25	26	27	28	29	30	

## DEC 2024

M	T	W	T	F	S	S
					1	
2	3	4	5	6	7	8
9	10	11	12	13	14	15
16	17	18	19	20	21	22
23	24	25	26	27	28	29
30	31					



# How to Hire

## Terms

All items are hired under "Construction Plant Hire Association" terms, these can be requested from a member of staff or viewed on our website.

## Delivery

Please call for delivery charges.

## Fuel

Prices quoted exclude fuel. We can supply fuel if required, please contact the office for the current rate.

## VAT

All prices quoted exclude VAT at the current rate.

## Payment

Payment - Non-account holders are required to pay pre-hire inclusive of a deposit and will need to come into the depot to make payment and produce I.D.

For a credit account please either complete the online application form on our website, download the account form from the website or request a copy by contacting [accounts@anglianplant.com](mailto:accounts@anglianplant.com).

We endeavour to open accounts within 24 hours of receipt of a completed application.

Call **01603 975000**

Options: 1 – Hire Desk 2 – Service  
3 – Accounts 4 – General Enquiries

Hire Desk

[hire@anglianplant.com](mailto:hire@anglianplant.com)

Service Department

[service@anglianplant.com](mailto:service@anglianplant.com)

Accounts

[accounts@anglianplant.com](mailto:accounts@anglianplant.com)

[www.anglianplant.com](http://www.anglianplant.com)



SCAN ME

**anglianplant**  
PLANT & TOOL | HIRE & SALES

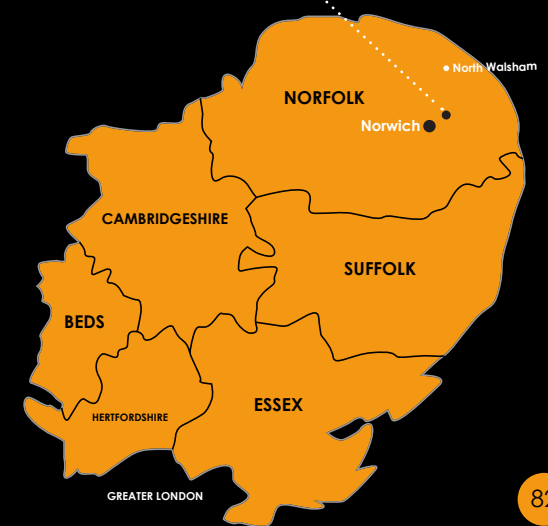

# anglianplant

Plant & Tool | Hire & Sales

